

Tubular Gel OPzV 24V System

Discover[®] Tubular OPzV 24V Systems provide superior deep cycling performance and reliability for demanding commercial, industrial and residential applications. Whether it's for solar application as an investment, or as power source for critical operations, Discover has a reliable power solution.

MECHANICAL DRAWINGS

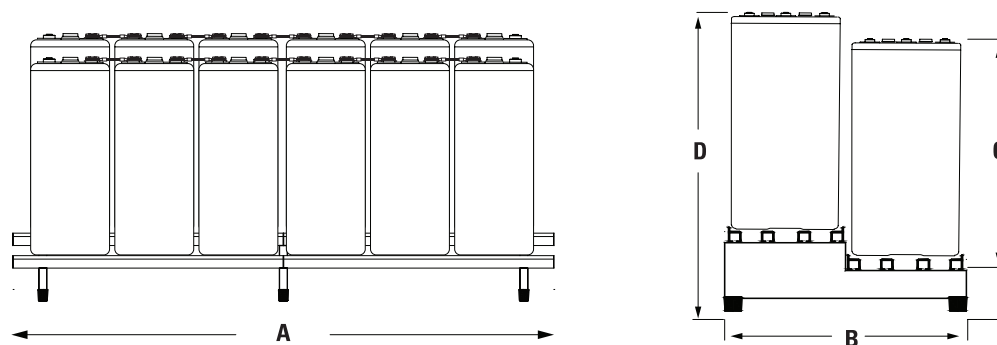

MECHANICAL SPECIFICATIONS

Voltage	24	
Industry Reference	Tubular Gel OPzV	
Length (A)	53.15 in	1350 mm
Width (B)	33.86 in	860 mm
Height (C)	39.13 in	994 mm
Total Height (D)	43.07 in	1094 mm
Weight	4,127 lbs	1,872 kgs
Cell(s)	12	
Cell Container	ABS	
Rack	Steel	

ELECTRICAL SPECIFICATIONS

Reference LVD / I10	20% DOD	24.60V
	50% DOD	23.64V
	80% DOD	22.92V
Cycle Life	20% DOD	7000 cycles
	50% DOD	2950 cycles
	80% DOD	1900 cycles
Internal Resistance	0.21 mΩ	
Short Circuit	10500 A	
Self Discharge	2-3% per month	
Maximum Operating Temperature	-35°C / -31°F 50°C / 122°F	
Electrolyte	Gel	

ELECTRICAL SPECIFICATIONS

240 HR	120 HR	100 HR	20 HR	10 HR	5 HR	3 HR	1 HR
1.85 Volts Per Cell (VPC)			1.75 Volts Per Cell (VPC)				
2981 AH	2966 AH	2927 AH	2376 AH	2160 AH	1960 AH	1701 AH	1049 AH

NOTE: All Electrical Specifications are based on 20°C / 68°F temperature.

BENEFITS & FEATURES

Engineered to deliver 80% of rated capacity above 1.90 Volts.

Low cost per cycle. OPzV batteries provide the Lowest Total Cost of Ownership amongst lead acid technologies. Further savings can be achieved in Hybrid systems through diesel abatement and peak shaving.

Complete System. Available in 24V and 48V configurations and ready to install (connectors and battery rack included). Flame retardant (UL 94-V0) containers available upon request.

Tubular positive plates and proprietary alloy compositions to provide a 50% Depth of Discharge cycle life of up to 2950 cycles @ 20°C / 68°F.



Sealed technology. Gel electrolyte and safety pressure relief valve with integral flame arrestor. Battery containers are made of Acrylonitrile Butadiene Styrene (ABS).



Sliding Pole Terminals. Designed to accommodate natural grid growth occurrence throughout battery lifetime.

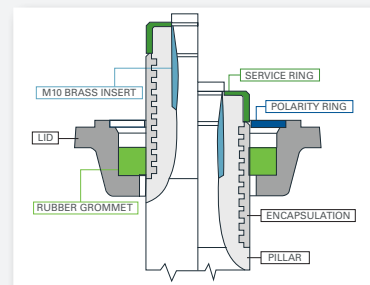

CERTIFIED QUALITY

Discover and its facilities and products are certified to multiple standards and compliance:

- ISO 9001/14001 and OSHA 18001 standards
- IEC 60896-21: Requirements for Photovoltaic Energy
- IEC 60896-22: Requirements for Valve Regulated Lead Acid batteries
- IEC 61427: Standard for photovoltaic energy systems
- DIN 40742: Standard for stationary tubular plate cells
- EN 50272-1 / 50272-2: Safety Requirements for stationary batteries
- UN 2800 (US DOT Compliance)
- Eurobat "Long Life" classification



EXPECTED NUMBER OF CYCLES IN RELATION TO THE DEPTH OF DISCHARGE

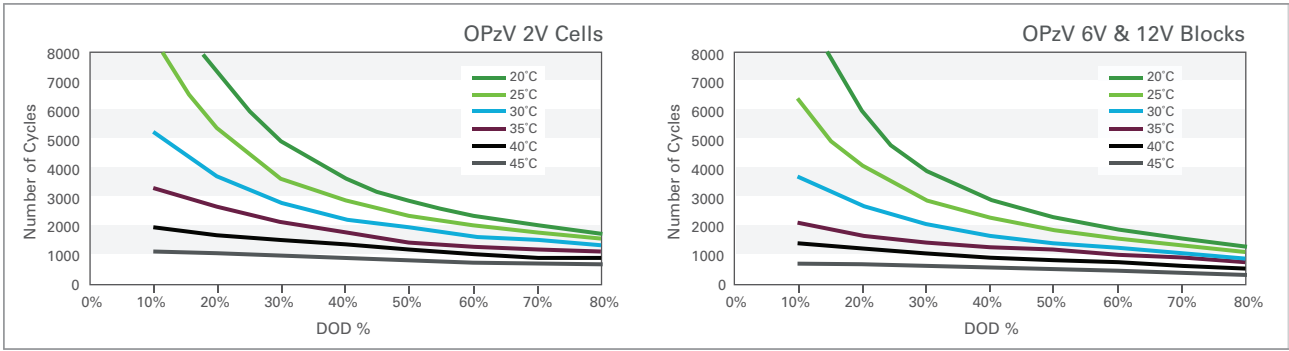

CAPACITY IN RELATION TO THE TEMPERATURE

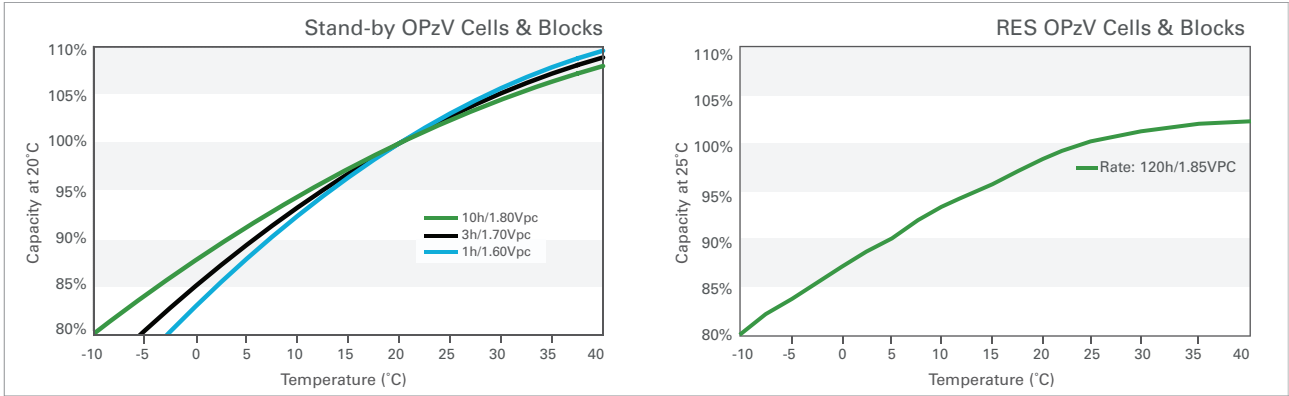

SELF-DISCHARGE CHARACTERISTICS

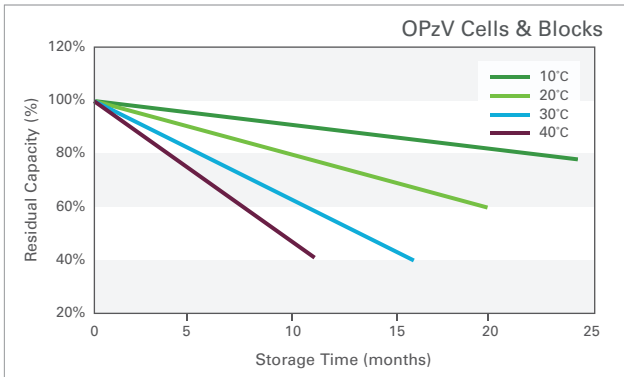

EXPECTED SERVICE LIFE IN RELATION TO OPERATING TEMPERATURE

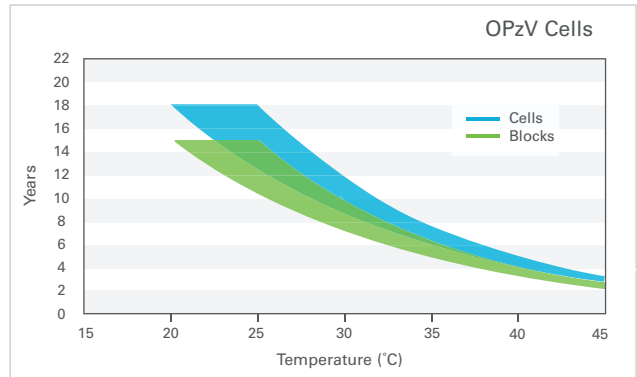

Float Voltage Setting in Relation to Operating Temperature

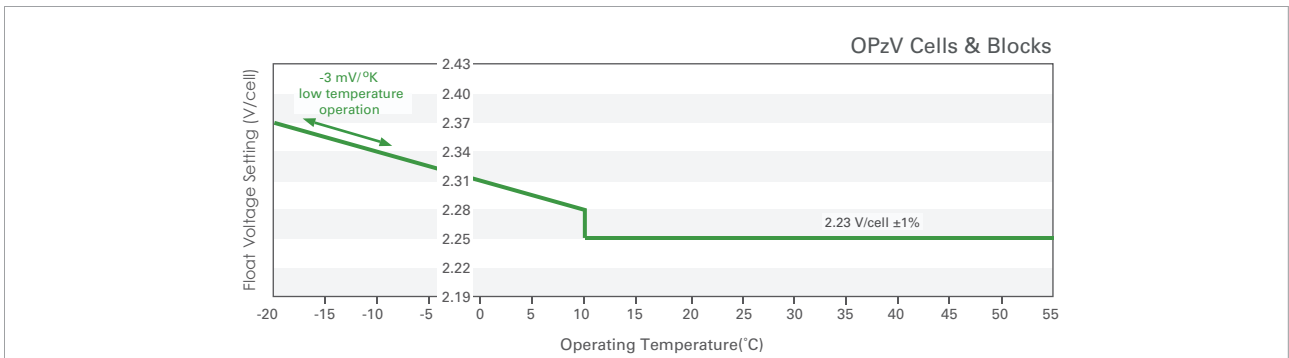

Discover® attempts to ensure the correctness of the product description and data contained herein. We reserve the right to change designs, specifications and pricing at any time without notice or obligation. It is the responsibility of the reader of this information to verify any and all information presented herein.